

CATALOG

# Softstarters for water and wastewater PSTX



---

**Motors use almost one third of the world's generated electricity. So it is safe to say that reliable motor operation is crucial to our modern way of life.**

**The PSTX combines many years of research and product development with extensive knowledge of application specific requirements and needs. It is our latest advancement in motor control & protection, and it adds new functionality and increased reliability.**

---

# Contents

<b>4</b>	<b>PSTX Softstarters</b>
<b>5</b>	<b>Common applications for softstarters</b>
<b>6</b>	<b>Motor starting</b>
<b>7</b>	<b>Standard Features</b>
<b>8</b>	<b>Introduction</b>
<b>10</b>	<b>Overview</b>
<b>15</b>	<b>Ordering details</b>
<b>17</b>	<b>Accessories</b>
<b>19</b>	<b>Fieldbus communications</b>
<b>12</b>	<b>Technical data</b>
<b>20</b>	<b>Dimensions</b>
<b>22</b>	<b>Circuit diagrams</b>
<b>23</b>	<b>Wall mounting</b>
<b>24</b>	<b>Certifications and approvals</b>
<b>25</b>	<b>Marketing materials and tools</b>

---

 PSTX SOFTSTARTERS

# PSTX Softstarters

## For water & wastewater applications



ABB's PSTX softstarter provide industry-specific features that will help optimize your water & wastewater (W&WW) pumping system and provide essential information at your fingertips.

### Simplify use

Application wizards simplify commissioning and control of your pump. Innovative pumping features designed for water and wastewater applications make it easier for you to program complex systems. Because ABB softstarters are part of the all-compatible experience, once you've learned the user interface, you can easily transfer your knowledge to the rest of ABB's all-compatible portfolio.

### Keep your pipes and pumps clean

ABB softstarters are well-suited for full speed pump applications. The soft ramping features increase pump life by reducing water hammer, and the pump cleaning feature reduces impeller buildup to prevent and clear pump clogging thereby eliminating downtime.

### Protect your system

Prolong the life of your system and increase uptime with features, such as motor preheat, which ensures a dry and warm motor. In addition, coated boards and IP66 / UL Type 4x externally mounted keypads make the PSTX suitable for installation in harsh conditions.

### Prolong the life of your pipes and pumps

The PSTX uses torque control to provide soft pipe fill to gently open and close valves and reduce water hammer during starts and stops.



# Common applications for softstarters

## Pumps and blowers

A softstarter can do wonders with your operations. Packed with useful features, it reduces the wear of your equipment, improve the reliability of your processes and increase overall productivity.



01 Softstarters controlling pumps

### Pump

#### Eliminating water hammer with torque control

Water hammer is a common problem with pumps and typically results in wear in pipes and valves when starting and stopping the pump. The ABB softstarter feature torque control provides a soft pipe fill during start and eliminates water hammer during stop. The benefits are prolonged lifetime of the system and increased uptime.

#### Keep pipes and pumps clean

Many pumps risk getting clogged over time. This will cause reduced flow and increased risk of pump damage. Thanks to the feature to reverse the direction of the flow and start again with kick-start, ABB softstarters can help prevent and solve pump clogging and associated downtime.

#### Avoid running dry with underload protection

Damages due to pumps running dry can be avoided with the softstarter feature dry pump protection, called underload protection. It stops the motor which saves the pump from additional wear and contributes to prolonging its lifetime.

### Blowers

#### Soft starting adjusted to application

Blowers normally have a high moment of inertia, which makes starting tough and current high. Using an ABB softstarter, the voltage is increased gradually during startup, which reduces the current and removes the inrush peak. It is possible to adjust the settings to fit almost any starting condition, from unloaded to fully loaded.

#### Fast stops with motor braking

It can also take a long time to stop a blower. With the dynamic brake feature, also called flux braking, the stopping time can be reduced. This improves process safety when the load has a high moment of inertia and makes operation easier for the operator.

#### Avoid unwanted movements with stand still brake

An idle blower that is rotating backwards, due to wind or airflow from another blower, can be kept still using the stand still brake. It prevents unwanted airflow and improves the control of the system without the need for an external mechanical brake.

01



# Motor starting

## Why motor starting and stopping matters

There are some common issues associated with starting and stopping electrical motors. Depending on requirement, different starting and stopping methods can be used.



### Softstarter

Like direct-on-line and star delta starters, softstarters are used to start and stop motors in full-speed applications. It eliminates common problems associated with motor starting and stopping, including electrical surges, spikes and high inrush currents. Because it offers soft starting and stopping, a softstarter is the optimal compromise between a direct-on-line or star-delta starter and a variable speed drive in many full-speed motor applications.



### Variable speed drive

Like a softstarter, a variable speed drive (VSD) can perform soft motor starting and stopping. However, the VSD was designed primarily to control motor speed, resulting in energy efficient motor operation in variable speed applications. Using a VSD with the sole purpose of ensuring soft starting and stopping of full-speed motors can therefore be considered an unnecessarily advanced solution.

### Typical torque and current curves from starting a motor using DOL, star-delta and softstarter.

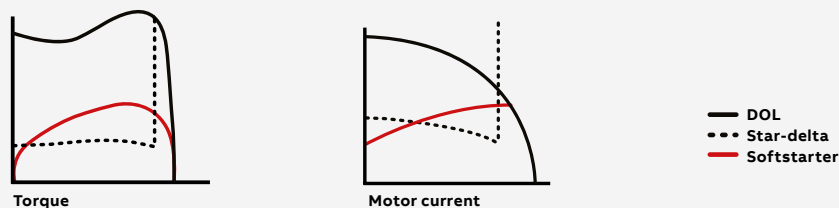

### Comparison between different starting methods

The table below describes which problems are prevented, using the most common starting methods.

Comparison	Starting method type			
	Direct on line DOL	Star-delta start Y/D	Softstarter	Drive
Reduce high inrush current	No	Yes	Yes	Yes
Reduce heavy wear on bearings, shafts, gear boxes, etc	No	Reduced	Yes	Yes
Prevent slipping belts	No	Reduced	Yes	Yes
Remove torque/current peaks	No	No	Yes	Yes
Prevent water hammer in piping system	No	No	Yes	Yes
Need of variable speed control	No	No	No	Yes



# PSTX

## Standard Features



### SECURE MOTOR **Reliability**

#### Secure Motor Reliability

- Current limit
- Current limit ramp and dual current limit
- Electronic motor overload protection
- Dual overload protection
- Underload protection
- Power factor underload protection
- Locked rotor protection
- Current/Voltage imbalance protection
- Phase reversal protection
- Customer defined protection
- Motor heating
- PTC/PT100 input for motor protection
- Overvoltage/undervoltage protection
- Earth-fault protection



### IMPROVE INSTALLATION **Efficiency**

#### Improve Installation Efficiency

- Built-in bypass
- Inside-delta connection possible
- Graphical display and keypad
- Detachable keypad
- Motor runtime and start count
- Programmable warning functions
- Diagnostics
- Overload time-to-trip
- Overload time-to-cool
- Analog output
- Fieldbus communication
- Event log
- 17 Multiple languages
- Electricity metering



### INCREASE APPLICATION **Productivity**

#### Increase Application Productivity

- Torque control
- Torque limit
- Coated PCBA
- Limp mode
- Jog with slow speed forward/ reverse
- Dynamic brake
- Stand still brake
- Sequence start
- Full voltage start
- Kick start
- Automatic pump cleaning

# Introduction

## for PSTX - the advanced range



- Rated operational current: 30 to 1250 A
- Three-phase controlled
- Operational voltage: 208 – 690 VAC
- Wide rated control supply voltage: 100 – 250 V, 50/60 Hz
- Coated circuit boards protecting from dust, moist and corrosive atmosphere
- Detachable keypad rated IP66 (4X outdoor)
- Graphical display with 17 languages for easy setup and operation
- Built-in bypass for energy saving and easy installation
- Built-in Modbus RTU for monitoring and control
- Support for all major communication protocols
- Analog output for measurement of current, voltage, power factor etc.



SECURE  
MOTOR

**Reliability**

### Complete motor protection

The PSTX offers complete motor protection in only one unit and is able to handle both load and network irregularities. PT-100, earth fault protection and over/under voltage protection along with many other functions keep your motor safer than ever. PSTX also offers three types of current limit: standard, dual and ramp. This gives you full control of your motor during start. It also allows you to use your motor in weaker networks.



IMPROVE  
INSTALLATION

**Efficiency**

### Built-in bypass saves time and energy

When reaching full speed, the PSTX will activate its bypass. This saves energy while reducing the softstarters heat generation. On the PSTX, the bypass is built in and verified by ABB, saving you time during installation and space in your panel.



INCREASE  
APPLICATION

**Productivity**

### Complete control of pumps

Time to use your processes to their full potential. The PSTX features many application enhancing features, including torque control: the most efficient way to start and stop pumps. The pump cleaning feature can reverse pump flow and clean out pipes, securing uptime of your pump system.





**IP66**

**Control Panel**

A user-friendly and clear display saves you time and resources during both setup and operation. The detachable keypad is standard on all PSTX softstarters with IP66 and 4x outdoor for tough environments.



**Jog with slow speed forward & reverse**

The slow speed forward and backward jog feature will help verify proper pump operation and shaft direction..



**Coated PCB**

Coated circuit boards protecting from dust, moist and corrosive atmosphere



**Heavy duty**

Designed to handle heavy applications such as high solids pumps, sludge pumps, and belt presses.



**Torque control**

The torque control function the absolutely best possible stop of pumps without water hammer and pressure surges.



**Customizable**

The PSTX has 17 pre-installed languages along with options to customize your own specific home screens (up to seven different). You can use your customized home screens to show status information important to your process and hide information that is not.



**Easy to learn**

A large graphical display along with built-in assistants make learning how to handle the PSTX fun and simple. The interface resembles other interfaces from ABB which will streamline and help with training of field personnel.



**Detachable**

The PSTX comes with a detachable keypad as standard. It can be placed on your panel door, meaning you do not have to interrupt your process in order to read status information or to change settings.

# PSTX

## Overview



PSTX30... PSTX105   PSTX142... PSTX170   PSTX210... PSTX370   PSTX470... PSTX570   PSTX720... PSTX840   PSTX1050... PSTX1250

Normal start In-Line connected (480 V) hp UL, max. FLA	PSTX30	PSTX37	PSTX45	PSTX60	PSTX72	PSTX85	PSTX105	PSTX142	PSTX170
	15	18.5	22	30	37	45	55	75	90
	28	34	42	60	68	80	104	130	169
<b>400 V, 40 °C</b>									
Using manual motor starter or MCCB, type 1 coordination will be achieved. <sup>1)</sup>	<b>MCCB (50 kA)</b>								
	XT2S160	XT2S160	XT2S160	XT2S160	XT2S160	XT2S160	XT2S160	XT2S160	XT4S250
Using gG fuses, type 1 coordination will be achieved. To achieve type 2 coordination, semiconductor fuses must be used. <sup>1)</sup>	<b>Fuse protection (80 kA), Semiconductor fuses, Bussmann</b>								
	170M1567	170M1568	170M1569	170M1569	170M1571	170M1572	170M3819	170M5810	170M5812
Suitable switch fuse for the recommended semiconductor fuses. <sup>1)</sup>	<b>Switch fuse</b>								
	OS32G	OS63G	OS63G	OS63G	OS125G	OS125G	OS250	OS400	OS400
The line contactor is not required for the softstarter itself but often used to open if OL trips <sup>1)</sup>	<b>Line contactor</b>								
	AF30	AF38	AF52	AF65	AF80	AF96	AF116	AF146	AF190

<sup>1)</sup> These is an example of coordination. For more examples see: [applications.it.abb.com/SOC](http://applications.it.abb.com/SOC)



PSTX30... PSTX105   PSTX142... PSTX170   PSTX210... PSTX370   PSTX470... PSTX570   PSTX720... PSTX840   PSTX1050... PSTX1250

<b>Normal start In-Line connected</b>	<b>PSTX210</b>	<b>PSTX250</b>	<b>PSTX300</b>	<b>PSTX370</b>	<b>PSTX470</b>	<b>PSTX570</b>	<b>PSTX720</b>	<b>PSTX840</b>	<b>PSTX1050</b>	<b>PSTX1250</b>
<b>(480 V) hp</b>	110	132	160	200	250	315	400	450	560	710
<b>UL, max. FLA</b>	192	248	302	361	480	590	720	840	1062	1250
<b>400 V, 40 °C</b>										
<b>Using manual motor starter or MCCB, type 1 coordination will be achieved.<sup>1)</sup></b>	<b>MCCB (50 kA)</b>									
	T4S320	T5S400	T5S400	T5S630	T7S800	T7S800	T7S1250	T7S1250	E2.2N 2000	E2.2N 2000
<b>Using gG fuses, type 1 coordination will be achieved. To achieve type 2 coordination, semiconductor fuses must be used.<sup>1)</sup></b>	<b>Fuse protection (80 kA), Semiconductor fuses, Bussmann</b>									
	170M5812	170M5813	170M6812	170M6813	170M6813	170M6814	170M8554	170M6018	170M6020	170M6021
<b>Suitable switch fuse for the recommended semiconductor fuses.<sup>1)</sup></b>	<b>Switch fuse</b>									
	OS400	OS400	OS630	OS630	OS630	OS630	OS800	-	-	-
<b>The line contactor is not required for the softstarter itself but often used to open if OL trips.<sup>1)</sup></b>	<b>Line contactor</b>									
	AF265	AF265	AF305	AF370	AF580	AF580	AF750	AF1350	AF1650	-

<sup>1)</sup> These is an example of coordination. For more examples see: [applications.it.abb.com/SOC](http://applications.it.abb.com/SOC)

# Technical data

Technical data		PSTX30 ... PSTX1250	
Rated insulation voltage $U_i$		690V	
Rated operational voltage $U_e$		208...600 V, 208...690V +10% / -15%, 50/60Hz ±10%	
Rated control supply voltage $U_s$		100...250 V +10% / -15%, 50/60Hz ±10%	
Rated control circuit voltage $U_c$		Internal or external 24 V DC	
Starting capacity at $I_e$		4 x $I_e$ for 10 sec.	
Number of starts per hour		10 for PSTX30 ... PSTX370 <sup>1)</sup> 6 for PSTX470 ... PSTX1250 <sup>1)</sup>	
Overload capability	Overload class	10	
Ambient temperature	During operation	-25...+60 °C, (-13...+140 F) <sup>2)</sup>	
	During storage	-40...+70 °C, (-40...+158 F)	
Maximum altitude		4000 m (13123 ft) <sup>3)</sup>	
Degree of protection	Main circuit	-	
	Supply and control circuit	IP20	
Main circuit	Built-in bypass contactor	Yes	
	Cooling system - Fan cooled	Yes (thermostat controlled)	
HMI for settings	Display	LCD type, graphical	
(Human Machine Interface)	Languages	English, Arabic, Chinese, Czech, Dutch, Finnish, French, German, Greek, Indonesian, Italian, Polish, Portuguese, Russian, Spanish, Swedish and Turkish	
	Keypad	2 selection keys, 4 navigation keys, start key, stop key, info key and remote/local key	
Signal relays	Number of programmable signal relays	3 (each relay can be programmed to None, Run, Top of ramp, Event group 0-6, Sequence 1-3 Run, Sequence 1-3 Top of ramp or Run reverse)	
	K4	Default as Run signal	
	K5	Default as Top of Ramp (Bypass) signal	
	K6	Default as Event group 0 (Faults)	
	Rated operational voltage, $U_e$	250 V AC/24 V DC	
	Rated thermal current $I_{th}$	5 A	
	Rated operational current $I_e$ at AC-15 ( $U_e=250$ V)	1.5 A	
Analog output	Output signal reference	0...10 V, 0...10 mA, 0...20 mA, 4...20 mA	
	Type of output signal	Motor current (A), Main voltage (V), Active power (kW), Active power (HP), Reactive power (kVAR), Apparent power (kVAh), Active energy (kWh), Reactive energy (kVAh), cos phi, Motor temperature (%), Thyristor temperature (%), Motor voltage (%), Main frequency (Hz), PT100 temperature (centigrade), PTC resistance (Ohm)	
Control circuit	Number of inputs	2 (start, stop)	
	Number of additional programmable inputs	3 (each input can be programmed to: None, Reset, Enable, Slow speed forward (Jog), Slow speed reverse (Jog), Motor heating, Stand still brake, Start reverse, User defined protection, Emergency mode (active high), Emergency mode (active low), Fieldbus disable control, Start 1, Start 2, Start 3, Switch to remote control or Cancel brake)	
Signalling indication LED	Ready	Green	
	Run	Green	
	Fault	Red	
	Protection	Yellow	
External keypad	Detachable keypad	Yes	
	Display	LCD type, graphical	
	Ambient temperature		
	During operation	-25...+60 °C, (-13...+140 F)	
During storage	-40...+70 °C, (-40...+158 F)		
Start and stop functions	Degree of protection	IP66 (Type 1, 4X, 12)	
	Soft start with voltage ramp	Linear voltage ramp, suitable for most applications	
	Soft stop with voltage ramp	Used to prolong the stop sequence	
	Soft start with torque control	Linear torque ramp, the best way to start pumps	
	Soft stop with torque control	Commonly used to reduce water hammer in pumps	
	Kick start	More power in the start for heavy duty applications.	
	Full voltage start	0.5 second start ramp for applications with need of high starting torque	
	Sequence start	Start multiple motors with one softstarter	
	Current limit	Limits the current below a specified value	
	Dual current limit	Consist of a low level, a high level and a time between them	
	Current limit ramp	A linear increase of the current from the low to the high level	
	Torque limit	Limit the torque to between 20-200%	
	Pre-start function	Use Motor heating, Stand still brake or Jog automatically prior to start ramp	
	Jog with slow speed, forward and reverse	Run the motor in three different speeds, both forward and reverse	
	Start reverse (external contactors)	Internal logic that allows control of external contactors for reverse start	
	Dynamic brake	Provides a braking force to decrease stop time	
	Fieldbus connection	Built-in Modbus RTU	Yes, with RS485 interface on terminals 23 and 24
		Connection for Anybus	Yes, including most common protocols, see catalog for details
		Connection for ABB Fieldbus plug	Yes, compatible with a special adapter, see catalog for details

<sup>1)</sup> Valid for normal start (class 10) for 50% on time and 50% off time. If other data is required, contact your local ABB office.

<sup>2)</sup> Above 40 °C (104 F) up to max. 60 °C (140 F) reduce the rated current with 0,8% per °C (0,44% per F).

<sup>3)</sup> When used at high altitudes, above 1000 meters (3281 ft) up to 4000 meters (13123 ft), de-rate the rated current using the following formula.

[ % of  $I_e = 100 - x \cdot 10000$  ] x = actual altitude of the softstarter in meter, [ % of  $I_e = 100 - x \cdot 3280$  ] x = actual altitude of the softstarter in feet. For de-rating of voltage, contact your local ABB office. 150

Technical data	PSTX30 ... PSTX1250
<b>Protections</b>	
Electronic overload protection, EOL	User defined, class 10A, 10, 20, 30
Dual overload (separate overload for start and run)	Possible to set separate overloads for start and full speed
PTC connection	User defined temperature control with external PTC sensor
PT-100 connection	User defined temperature control with external PT-100 sensor
Locked rotor protection	Prevents start if motor is stuck, e.g. stuck pumps and conveyors
Current underload protection	Stops the process if the load is too light, e.g. a pump running dry
Current imbalance protection	User defined, checks current imbalance between the phases
Power factor underload protection	User defined, trip if power factor is out of range
Under voltage protection	User defined, prevents the motor from stalling in weak networks
Over voltage protection	User defined, prevents the motor from damage at high voltage levels
Voltage imbalance protection	User defined, checks voltage imbalance between the phases
Earth fault protection / ground fault protection	User defined, 0.1-1.0 sec, stops the process if earth fault is detected
Phase reversal protection	Prevents start if phases are connected in the wrong order
Bypass open protection	Trips if the bypass is open when it should be closed
User defined protection	Programmable input, can be used with external protection device
Too long current limit protection	User defined, trips when the current has been at the current limit for too long time
HMI failure protection	Indicates communication failure between softstarter and HMI
Fieldbus failure protection	Indicates communication failure between softstarter and PLC
Extension IO failure protection	Indicates communication failure between softstarter and IO module
Max number of starts/hour	Prevents start if the thyristors gets too warm (thus used over specification)
Too long start time protection	User defined, trips when the starting time exceeds a set value
<b>Warnings</b>	
Current underload warning	User defined on/off
Current imbalance warning	User defined on/off
Voltage imbalance warning	User defined on/off
Thyristor overload warning (SCR)	User defined on/off
Electronic overload Time-to-trip	User defined on/off
Short circuit warning (for Limp mode)	User defined on/off, for Limp mode
Over voltage warning	User defined on/off
Under voltage warning	User defined on/off
Power factor underload warning	User defined on/off
Locked rotor warning	User defined on/off
Faulty fan warning	User defined on/off
THD(U) - Total Harmonic Distortion warning	User defined on/off
Motor runtime limit warning	User defined on/off
Phase loss warning (for stand by)	User defined on/off, for stand by
EOL warning	User defined on/off
<b>External faults detection</b>	
Phase loss	Yes
Hight current	Yes
Low control supply voltage	Yes
Faulty usage	Yes, e.g. using limp mode inside-delta
Faulty connection	Yes
Bad network quality	Yes
<b>Internal faults detection</b>	
Thyristor overload	Yes
Short circuit	Yes
Open circuit thyristor or gate	Yes
Heat sink over temperature	Yes
Shunt fault	Yes
<b>PTC input</b>	
Switch off resistance	2825 ohm $\pm$ 20%
Switch on resistance	1200 ohm $\pm$ 20%
<b>Other functions</b>	
Real time clock	Can maintain time when the softstarter isn't powered up, 48 h back-up
Event log	Log of events such as trips, parameters changed and operation
Emergency mode	To keep the softstarter running regardless of trip or failure. Activated via DI
Automatic restart	In case of trip and stopped motor, the softstarter can restart itself
Keypad password	Lock the keypad to inhibit unauthorized motor control
Pump cleaning	Can reverse pump flow and clean out pipes
Electronic overload Time-to-cool	Time until the motor is ready to be restarted after an EOL trip
Thyristor runtime measurement	Measures most electrical variables, e.g. voltage, current and power
Auto phase sequence detection	Detection of the phase sequence
Electricity metering	Measures most electrical variables, e.g. voltage, current and power
Motor heating	DC injection in all windings to heat up the motor. Useful in cold or humid environment
Stand still brake	Prevents the motor from moving, useful to keep fans from reversing
Voltage sags detection	User defined
Limp mode with two-phase motor control if one set of thyristors is shorted	Can keep process running until planned maintenance

For all functions and features see installation and commissioning manual, 1SFC132081M0201 available on [new.abb.com/low-voltage/products/Softstarters](http://new.abb.com/low-voltage/products/Softstarters).

# Technical data

Fuse ratings and power losses						
For softstarter	Current range	Max power loss at rated $I_e$	Max fuse rating - main circuit <sup>1) 2)</sup> Bussmann fuses, DIN43 620 (Knife)			Power requirements supply circuit holding (VA) / Pull-in (VA)
Type	A	W	A	Type	Size	
PSTX30	9.0...30.0	0.8	100	170M1567	000	49/51
PSTX37	11.1...37.0	1.2	125	170M1568	000	49/51
PSTX45	13.5...45.0	1.8	160	170M1569	000	49/51
PSTX60	18.0...60.0	3.2	160	170M1569	000	49/51
PSTX72	21.6...72.0	4.7	250	170M1571	000	49/51
PSTX85	22.5...85.0	6.5	315	170M1572	000	49/51
PSTX105	31.8...106.0	10	400	170M3819	1*	49/51
PSTX142	42.9...143.0	18	500	170M5810	2	49/53
PSTX170	51.3...171.0	26	630	170M5812	2	49/53
PSTX210	63.0...210.0	48	630	170M5812	2	56/276
PSTX250	75.0...250.0	68	700	170M5813	2	56/276
PSTX300	90.0...300.0	97	800	170M6812	3	56/276
PSTX370	111.0...370.0	148	900	170M6813	3	56/276
PSTX470	141.0...470.0	99	900	170M6813	3	67/434
PSTX570	171.0...570.0	146	1000	170M6814	3	67/434
PSTX720	216.0...720.0	78	1250	170M8554	3	61/929
PSTX840	252.0...840.0	106	1500	170M6018	3	61/929
PSTX1050 <sup>3)</sup>	315.0...1050.0	165	1800	170M6020	3	68/929
PSTX1250 <sup>3) 4)</sup>	375.0...1250.0	234	2000	170M6021	3	68/929

<sup>1)</sup> For the supply circuit 6 A delayed, for MCB use C characteristics.  
<sup>2)</sup> For inside delta connection the fuses shall be placed inside the delta. Contact ABB for more information.  
<sup>3)</sup> 170M6019 with fuse rating 1600 A should be used for 690 V version.  
<sup>4)</sup> For 690 V version, Bussmann fuses are only available for motors with rated current up to 1150 A.

PSTX Integrated bypass ratings						
Softstarter	PSTX470	PSTX570	PSTX720	PSTX840	PSTX1050	PSTX1250
Integrated contactor	AF370		AF750			AF1250
AC-3 rating at 400 V (A)	370		750			-
IEC AC-3 Rated operational power at 400 V (kW)	200		400			-
UL/CSA 3-phase motor rating at 480 V (hp)	300		600			-

Tripping curves for the integrated electronic overload protection. All units have an integrated electronic overload protection that can be set to four different tripping classes. Below you find a curve for each tripping class in cold state. These tripping curves are valid for PSTX.

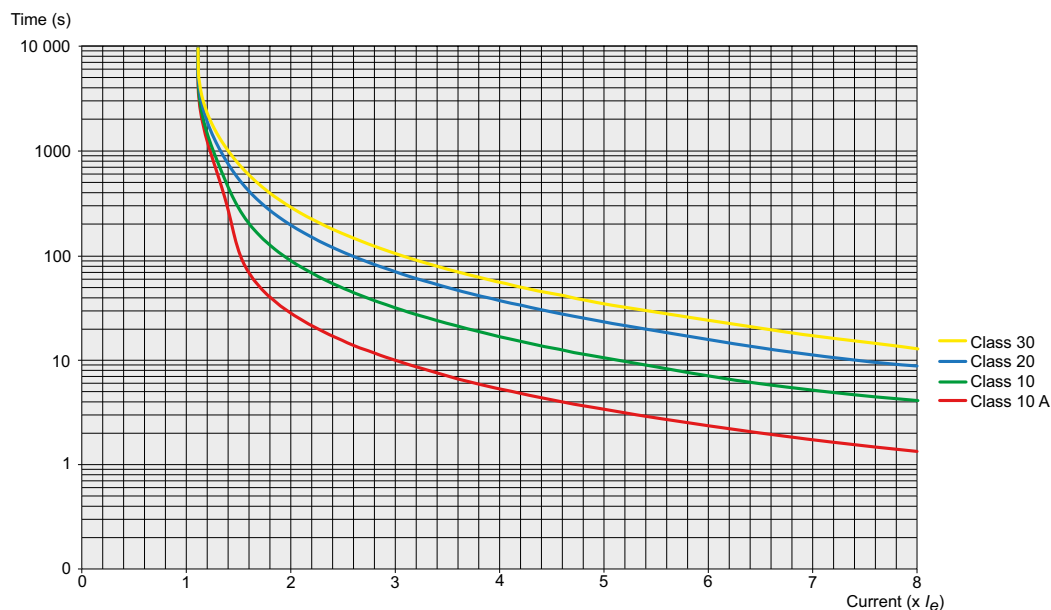

Tripping curves for electronic overload protection (cold) for PSTX.



# Ordering details

## Normal duty starts, class 10

### Typical applications

- Centrifugal pump
- Conveyor belt (short)
- Centrifugal blower
- Belt press



For a more precise selection, use the online softstarter selection tool available by scanning the shown QR code or using the selection tool available on: [new.abb.com/low-voltage/products/Softstarters](http://new.abb.com/low-voltage/products/Softstarters)



PSTX30... PSTX105



PSTX142... PSTX170



PSTX210... PSTX370



PSTX470... PSTX570



PSTX720... PSTX840



PSTX1050... PSTX1250

UL/CSA					Type	Weight	
Rated operational power 200/208V		220/240V	440/480V	550/600V	Current FLA A	pkg/1pce	
P <sub>e</sub> hp	P <sub>e</sub> hp	P <sub>e</sub> hp	P <sub>e</sub> hp	kg		(lb)	
<b>Rated operational voltage U<sub>e</sub>, 208...600 V , rated control supply voltage U<sub>s</sub>, 100...250 V AC, 50/60 Hz</b>							
7.5	10	20	25	28	PSTX30-600-70	6.10	(13.45)
10	10	25	30	34	PSTX37-600-70	6.10	(13.45)
10	15	30	40	42	PSTX45-600-70	6.10	(13.45)
20	20	40	50	60	PSTX60-600-70	6.10	(13.45)
20	25	50	60	68	PSTX72-600-70	6.10	(13.45)
25	30	60	75	80	PSTX85-600-70	6.10	(13.45)
30	40	75	100	104	PSTX105-600-70	6.10	(13.45)
40	50	100	125	130	PSTX142-600-70	9.60	(21.16)
50	60	125	150	169	PSTX170-600-70	9.60	(21.16)
60	75	150	200	192	PSTX210-600-70	12.70	(27.99)
75	100	200	250	248	PSTX250-600-70	12.70	(27.99)
100	100	250	300	302	PSTX300-600-70	12.70	(27.99)
125	150	300	350	361	PSTX370-600-70	12.70	(27.99)
150	200	400	500	480	PSTX470-600-70	25.00	(55.12)
200	200	500	600	590	PSTX570-600-70	25.00	(55.12)
250	300	600	700	720	PSTX720-600-70	46.20	(101.85)
300	350	700	800	840	PSTX840-600-70	46.20	(101.85)
400	450	900	1000	1062	PSTX1050-600-70	64.20	(141.54)
400	500	1000	1200	1250	PSTX1250-600-70	64.70	(142.64)
<b>Rated operational voltage U<sub>e</sub>, 208...690 V , rated control supply voltage U<sub>s</sub>, 100...250 V AC, 50/60 Hz</b>							
7.5	10	20	25	28	PSTX30-690-70	6.10	(13.45)
10	10	25	30	34	PSTX37-690-70	6.10	(13.45)
10	15	30	40	42	PSTX45-690-70	6.10	(13.45)
20	20	40	50	60	PSTX60-690-70	6.10	(13.45)
20	25	50	60	68	PSTX72-690-70	6.10	(13.45)
25	30	60	75	80	PSTX85-690-70	6.10	(13.45)
30	40	75	100	104	PSTX105-690-70	6.10	(13.45)
40	50	100	125	130	PSTX142-690-70	9.60	(21.16)
50	60	125	150	169	PSTX170-690-70	9.60	(21.16)
60	75	150	200	192	PSTX210-690-70	12.70	(27.99)
75	100	200	250	248	PSTX250-690-70	12.70	(27.99)
100	100	250	300	302	PSTX300-690-70	12.70	(27.99)
125	150	300	350	361	PSTX370-690-70	12.70	(27.99)
150	200	400	500	480	PSTX470-690-70	25.00	(55.12)
200	200	500	600	590	PSTX570-690-70	25.00	(55.12)
250	300	600	700	720	PSTX720-690-70	46.20	(101.85)
300	350	700	800	840	PSTX840-690-70	46.20	(101.85)
400	450	900	1000	1062	PSTX1050-690-70	64.20	(141.54)
400	500	1000	1200	1250	PSTX1250-690-70	64.70	(142.64)

# Ordering details

## Heavy-duty starts, class 30

### Typical applications

- Centrifugal pump (wastewater)
- Conveyor belt (long)
- Mixer
- Positive displacement pumps
- Positive displacement blower



For a more precise selection, use the online softstarter selection tool available by scanning the shown QR code or using the selection tool available on: [new.abb.com/low-voltage/products/Softstarters](http://new.abb.com/low-voltage/products/Softstarters)



PSTX30... PSTX105



PSTX142... PSTX170



PSTX210... PSTX370



PSTX470... PSTX570









PSTX720... PSTX840









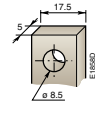
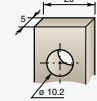
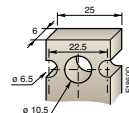
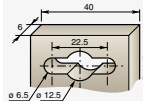
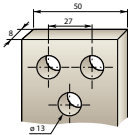

PSTX1050... PSTX1250

UL/CSA					Type	Weight	
Rated operational power 200/208V		440/480V	550/600V	Current		pkg/1pce	
P <sub>e</sub> hp	220/240V P <sub>e</sub> hp	P <sub>e</sub> hp	P <sub>e</sub> hp	FLA A		kg	(lb)
Rated operational voltage U <sub>e</sub> , 208...600 V, rated control supply voltage U <sub>s</sub> , 100...250 V AC, 50/60 Hz							
5	7.5	15	20	25	PSTX30-600-70	6.10	(13.45)
7.5	10	20	25	28	PSTX37-600-70	6.10	(13.45)
10	10	25	30	34	PSTX45-600-70	6.10	(13.45)
10	15	30	40	42	PSTX60-600-70	6.10	(13.45)
20	20	40	50	60	PSTX72-600-70	6.10	(13.45)
20	25	50	60	68	PSTX85-600-70	6.10	(13.45)
25	30	60	75	80	PSTX105-600-70	6.10	(13.45)
30	40	75	100	104	PSTX142-600-70	9.60	(21.16)
40	50	100	125	130	PSTX170-600-70	9.60	(21.16)
50	60	125	150	169	PSTX210-600-70	12.70	(27.99)
60	75	150	200	192	PSTX250-600-70	12.70	(27.99)
75	100	200	250	248	PSTX300-600-70	12.70	(27.99)
100	100	250	300	302	PSTX370-600-70	12.70	(27.99)
125	150	300	350	361	PSTX470-600-70	25.00	(55.12)
150	200	400	500	480	PSTX570-600-70	25.00	(55.12)
200	200	500	600	590	PSTX720-600-70	46.20	(101.85)
250	300	600	700	720	PSTX840-600-70	46.20	(101.85)
300	350	700	800	840	PSTX1050-600-70	64.20	(141.54)
400	450	900	1000	1062	PSTX1250-600-70	64.70	(142.64)
Rated operational voltage U <sub>e</sub> , 208...690 V, rated control supply voltage U <sub>s</sub> , 100...250 V AC, 50/60 Hz							
5	7.5	15	20	25	PSTX30-690-70	6.10	(13.45)
7.5	10	20	25	28	PSTX37-690-70	6.10	(13.45)
10	10	25	30	34	PSTX45-690-70	6.10	(13.45)
10	15	30	40	42	PSTX60-690-70	6.10	(13.45)
20	20	40	50	60	PSTX72-690-70	6.10	(13.45)
20	25	50	60	68	PSTX85-690-70	6.10	(13.45)
25	30	60	75	80	PSTX105-690-70	6.10	(13.45)
30	40	75	100	104	PSTX142-690-70	9.60	(21.16)
40	50	100	125	130	PSTX170-690-70	9.60	(21.16)
50	60	125	150	169	PSTX210-690-70	12.70	(27.99)
60	75	150	200	192	PSTX250-690-70	12.70	(27.99)
75	100	200	250	248	PSTX300-690-70	12.70	(27.99)
100	100	250	300	302	PSTX370-690-70	12.70	(27.99)
125	150	300	350	361	PSTX470-690-70	25.00	(55.12)
150	200	400	500	480	PSTX570-690-70	25.00	(55.12)
200	200	500	600	590	PSTX720-690-70	46.20	(101.85)
250	300	600	700	720	PSTX840-690-70	46.20	(101.85)
300	350	700	800	840	PSTX1050-690-70	64.20	(141.54)
400	450	900	1000	1062	PSTX1250-690-70	64.70	(142.64)

# Accessories

Terminal lug kits for Al and Cu cables		Wire range mm <sup>2</sup>	Tightening Nm torque max.	Catalog number	Pkg qty	Weight pkg / 1 pc	
						kg	(lb)
	PSTX142 - PSTX170	#6 - 300 MCM (1 per phase)	13.5 (275 lb-in)	ATK185	3	0.113	(0.249)
	PSTX210 - PSTX370	#4 - 400 MCM (1 per phase)	43 (375 lb-in)	ATK300	3	0.300	(0.661)
	PSTX210 - PSTX370	#4 - 500 MCM (2 per phase)	43 (375 lb-in)	ATK300/2	3	0.133	(0.293)
	PSTX470 - PSTX570	2/0 - 500 MCM (2 per phase)	43 (375 lb-in)	ATK580/2	3	0.570	(1.257)
	PSTX720 - PSTX840	2/0 - 500 MCM (3 per phase)	43 (375 lb-in)	ATK750/3	3	0.570	(1.257)
	PSTX1050 - PSTX1250	4/0 - 500 MCM (3 per phase)	43 (375 lb-in)	ATK1350/4 *	3	0.570	(1.257)
Terminal extensions		Dimensions hole ø mm <sup>2</sup>	bar mm	Catalog number	Pkg qty	Weight pkg / 1 pc	
						kg	(lb)
	PSTX142...PSTX170	8.5	17.5 x 5	LX205	1	0.250	(5.551)
	PSTX210...PSTX370	10.5	20 x 5	LX370	1	0.350	(0.772)
	PSTX470...PSTX570	11	25 x 5	LX460	1	0.500	(1.102)
	PSTX720...PSTX840	13	40 x 6	LX750	1	0.850	(1.874)
Terminal enlargements							
	PSTX30...PSTX105	6.5	15 x 3	LW110	1	0.100	(0.220)
	PSTX142...PSTX170	10.5	17.5 x 5	LW205	1	0.250	(5.551)
	PSTX210...PSTX370	11	20 x 5	LW370	1	0.450	(0.992)
	PSTX470...PSTX570	10.5	25 x 5	LW460	1	0.730	(1.609)
	PSTX720...PSTX840	13	40 x 6	LW750	1	1.230	(2.712)
Terminal shrouds			Req. qty	Catalog number	Pkg qty	Weight pkg / 1 pc	
						kg	(lb)
	PSTX142...PSTX170, short for use with cable clamps		2	LT205-30C	2	0.050	(0.110)
	PSTX142...PSTX170, long for use with compression lugs		2	LT205-30L	2	0.220	(0.485)
	PSTX210...PSTX370, short for use with cable clamps		2	LT370-30C	2	0.035	(0.077)
	PSTX210...PSTX370, long for use with compression lugs		2	LT370-30L	2	0.280	(0.617)
	PSTX210...PSTX370, long and deep for use with extending cable clamps, ATK300/2 and OZXB4		2	LT370-30D	2	0.150	(0.331)
	PSTX470...PSTX570, short for use with cable clamps		2	LT460-AC	2	0.100	(0.220)
	PSTX470...PSTX570, long for use with compression lugs		2	LT460-AL	2	0.800	(1.764)
	PSTX720...PSTX840, short for use with cable clamps		2	LT750-AC	2	0.120	(0.265)
	PSTX720...PSTX840, long for use with compression lugs		2	LT750-AL	2	0.825	(1.819)
	PSTX USB Cable				Catalog number	Pkg qty	Weight pkg / 1 pc
						kg	(lb)
	PSTX USB Cable			PSCA-1	1	0.054	(0.119)
I/O module, 24 V DC digital input							
	Extension module for I/O			DX111-FBP.0	1	0.220	(0.485)
	Extension module for I/O 24 VDC			DX122-FBP.0	1	0.220	(0.485)

# Accessories

Main terminals		PSTX30 ... PSTX105	PSTX142 ... PSTX170	PSTX210 ... PSTX370	PSTX470 ... PSTX570	PSTX720 ... PSTX1050	PSTX1250
							
	<b>Cu cable - flexible</b>	1 x mm <sup>2</sup>	10...70 mm <sup>2</sup>	6...120 mm <sup>2</sup>	16...240 mm <sup>2</sup>	-	-
	Clamp type	Included	1SDA066917R1	1SDA055016R1	-	-	-
	Tightening torque	8 Nm	14 Nm	25 Nm	-	-	-
	<b>Cu cable - flexible</b>	2 x mm <sup>2</sup>	6...35 mm <sup>2</sup>	50...95 mm <sup>2</sup>	70...185 mm <sup>2</sup>	-	-
	Clamp type	Included	LZ185-2C/120 1SFN074709R1000	OZXB4 <sup>1)</sup> 1SCA022194R0890	-	-	-
	Tightening torque	8 Nm	16 Nm	22 Nm	-	-	-
	<b>Cu cable - Stranded</b>	1 x mm <sup>2</sup>	10...95 mm <sup>2</sup>	6...150 mm <sup>2</sup>	16...300 mm <sup>2</sup>	-	-
	Clamp type	Included	1SDA066917R1	1SDA055016R1	-	-	-
	Tightening torque	8 Nm	14 Nm	25 Nm	-	-	-
	<b>Cu cable - Stranded</b>	2 x mm <sup>2</sup>	6...35 mm <sup>2</sup>	50...120 mm <sup>2</sup>	70...185 mm <sup>2</sup>	120...240 mm <sup>2</sup>	-
	Clamp type	Included	LZ185-2C/120 1SFN074709R1000	OZXB4 <sup>1)</sup> 1SCA022194R0890	1SDA013922R1	-	-
	Tightening torque	8 Nm	16 Nm	22 Nm	35 Nm	-	-
	<b>Cu cable - Stranded</b>	3 x mm <sup>2</sup>	-	-	-	70...185 mm <sup>2</sup>	-
	Clamp type	-	-	-	-	1SDA013956R1	-
	Tightening torque	-	-	-	-	45 Nm	-
	<b>Al cable - Stranded</b>	1 x mm <sup>2</sup>	-	95...185 mm <sup>2</sup>	185...240 mm <sup>2</sup>	-	-
	Clamp type	-	-	1SDA0549881R1	1SDA055020R1	-	-
	Tightening torque	-	-	31 Nm	43 Nm	-	-
	<b>Al cable - Stranded</b>	2 x mm <sup>2</sup>	-	-	120...240 mm <sup>2</sup>	-	-
	Clamp type	-	-	-	1SDA023380R1	-	-
	Tightening torque	-	-	-	31 Nm	-	-
	<b>Lugs</b>	Width ≤	24 mm (0.945 in)	32 mm (1.260 in)	47 mm (1.850 in)	50 mm (1.969 in)	50 mm (1.969 in)
	Diameter ≥	-	8 mm (0.355 in)	10.2 mm (0.402 in)	10.5 mm (0.413 in)	12.5 mm (0.492 in)	13 mm (0.519 in)
	Tightening torque	-	18 Nm (160 in lb)	28 Nm (248 in lb)	35 Nm (310 in lb)	45 Nm (398 in lb)	45 Nm (398 in lb)
<b>Connection capacity acc to UL / CSA 1 x AWG / kcmil</b>		6...2/0	6...300 kcmil	4...400 kcmil	-	-	-
	Clamp type	Included	ATK185	ATK300	-	-	-
	Tightening torque	71 in lb	300 in lb	375 in lb	-	-	-
<b>Connection capacity acc to UL / CSA 2 x AWG / kcmil</b>		-	-	4...500 kcmil	2/0...500 kcmil	2/0...500 kcmil	-
	Clamp type	-	-	ATK300/2 <sup>2)</sup>	ATK580/2	ATK580/2	-
	Tightening torque	-	-	375 in lb	375 in lb	375 in lb	-
<b>Connection capacity acc to UL / CSA 3 x AWG / kcmil</b>		-	-	-	2/0...500 kcmil	2/0...500 kcmil	-
	Clamp type	-	-	-	ATK750/3	ATK750/3	-
	Tightening torque	-	-	-	375 in lb	375 in lb	-
<b>Supply and control circuit</b>	Cu cable - Stranded 1 x mm <sup>2</sup>	0.75...2.5 mm <sup>2</sup> (19...14 AWG)					
	Cu cable - Stranded 2 x mm <sup>2</sup>	0.75...1.5 mm <sup>2</sup> (19...16 AWG)					
	Tightening torque	0.5 Nm (4.4 in lb)					

<sup>1)</sup> Terminal shrouds 1SFN125406R1000 must be used.

<sup>2)</sup> Terminal shrouds 1SFN125406R1000 can be used.

# Fieldbus communication

PSTX softstarters can be connected to a fieldbus network for monitoring and control. All major industrial fieldbus protocols are covered with different accessories making the installation very flexible.

## Built-in Modbus-RTU for PSTX

- Built-in Modbus RTU communication interface
- Easy to install using the Modbus RTU adaptor which is included with the Softstarter
- Through this communication interface it is possible to get full control and status information of the Softstarter as well as reading- and writing parameters

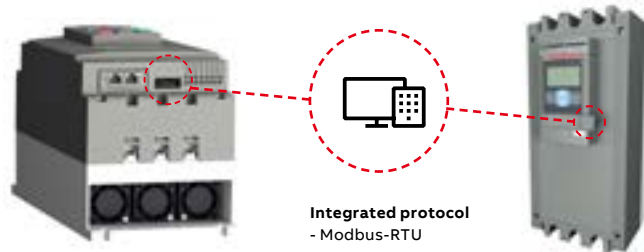

## Anybus connection for PSTX

- Anybus connection accessory for communication protocol suitable for PSTX30... PSTX1250

Available communication protocols for PSTX	
Communication	PSTX
Modbus RTU	●
Profibus DP	●
DeviceNet	●
Modbus TCP	●
Ethernet/IP	●

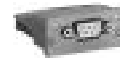

DeviceNet



EtherNet/IP (1-port)  
Modbus/TCP (1-port)



Profibus  
Modbus-RTU



EtherNet/IP (2-port)  
Modbus/TCP (2-port)  
Profinet (2-port)

### Anybus connection accessory for communication protocol suitable for PSTX30 ...PSTX1250

Type	Pkg qty	Weight pkg/1pce (lb)
Profibus AB-PROFIBUS-1	1	0.042 (0.093)
DeviceNet AB-DEVICENET-1	1	0.042 (0.093)
Modbus-RTU AB-MODBUS-RTU-1	1	0.042 (0.093)
EtherNet/IP (1-port) AB-ETHERNET-IP-1	1	0.042 (0.093)
EtherNet/IP (2-port) AB-ETHERNET-IP-2	1	0.042 (0.093)
Modbus/TCP (1-port) AB-MODBUS-TCP-1	1	0.042 (0.093)
Modbus/TCP (2-port) AB-MODBUS-TCP-2	1	0.042 (0.093)
Profinet (2-port) AB-PROFINET-2	1	0.042 (0.093)

# Dimensions

**Frame A**  
PSTX30...PSTX105

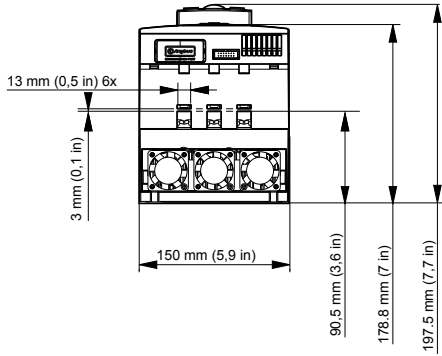

**Frame B**  
PSTX142...PSTX170

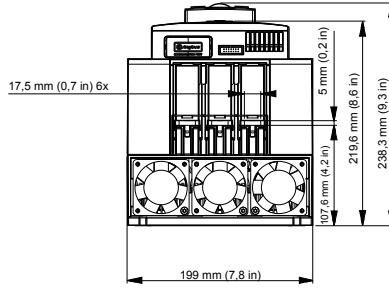

**Frame C**  
PSTX210...PSTX370

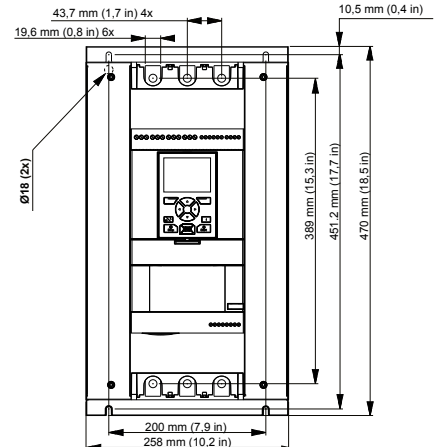
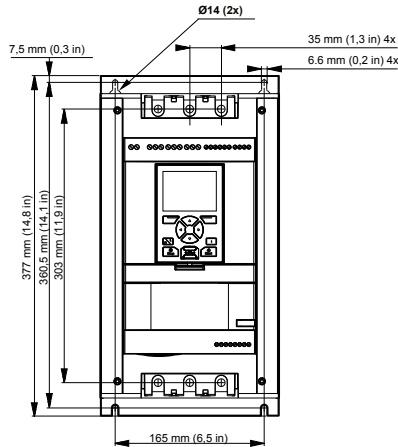
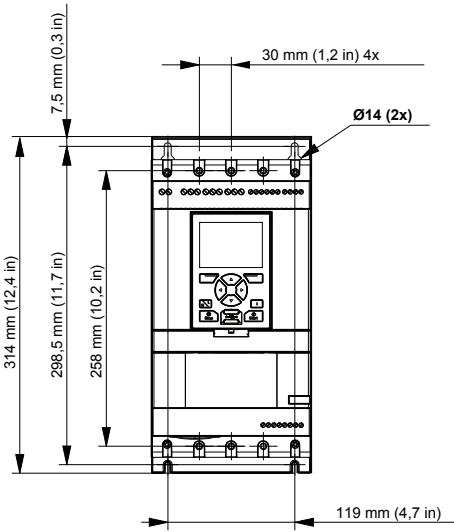
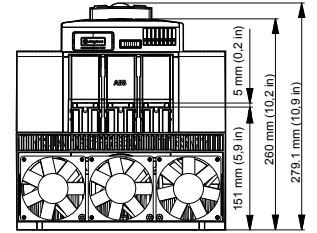

**Weight**  
6.1 lb (13.45 kg)

**Weight**  
9.6 lb (21.16kg)

**Weight**  
12.7 lb (27.99 kg)



**Frame D**  
PSTX470...PSTX570

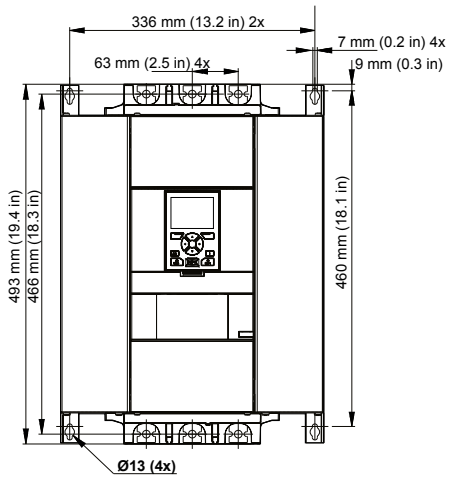
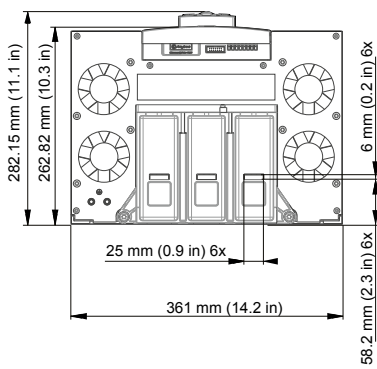

**Weight**  
25 lb (55.12 kg)

**Frame E**  
PSTX720...PSTX840

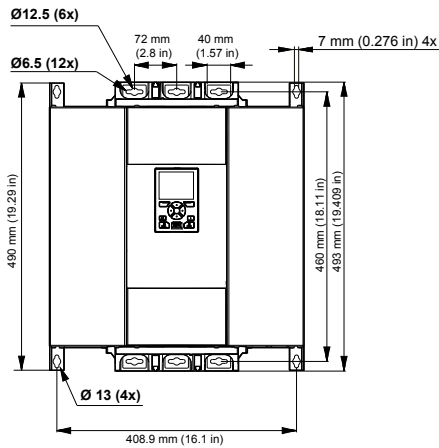
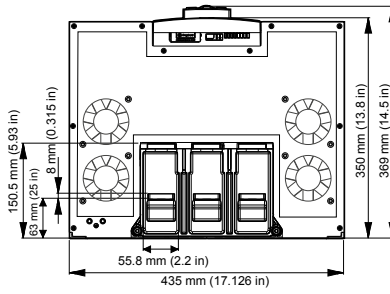

**Weight**  
46.2 lb (101.85 kg)

**Frame F**  
PSTX1050

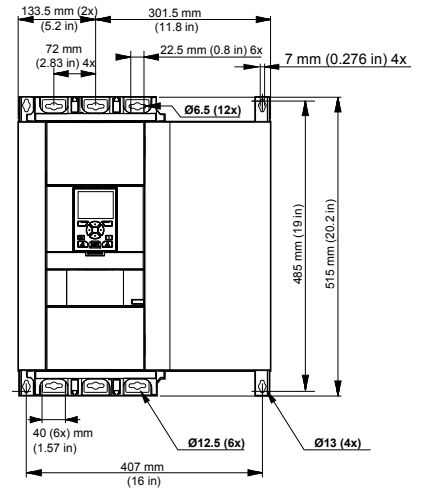
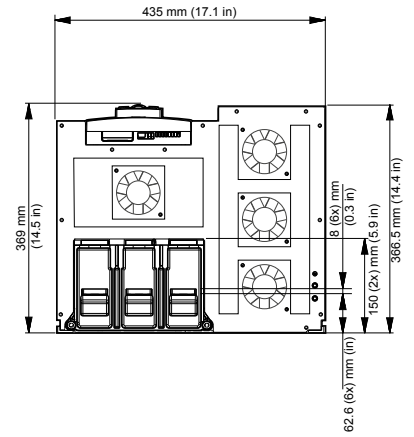

**Weight**  
64.2 lb (141.54 kg) PSTX1050  
64.7 lb (142.64 kg) PSTX1250

# Circuit diagrams



**CAUTION**

Terminal 22 is a function earth, it is not a protective earth. It shall be connected to the mounting plate.

**UL circuit diagram**

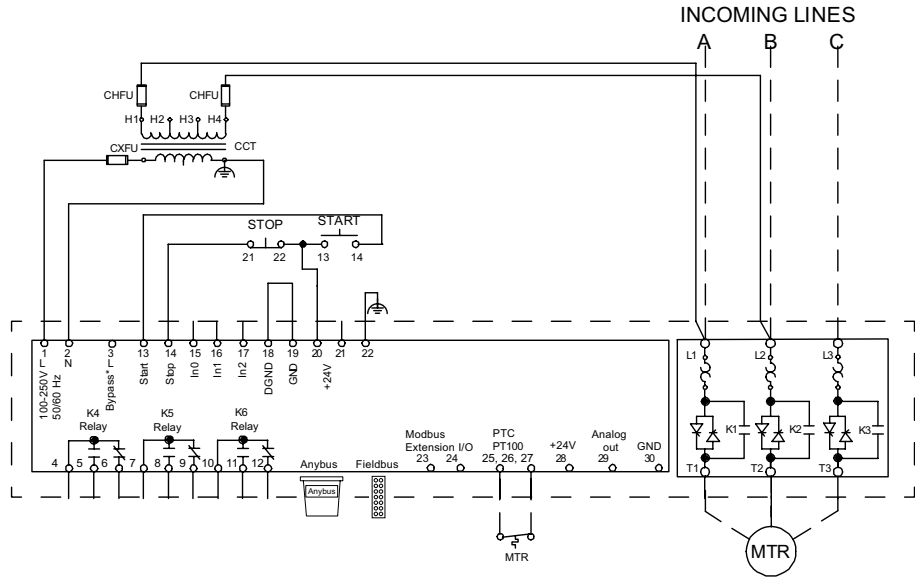
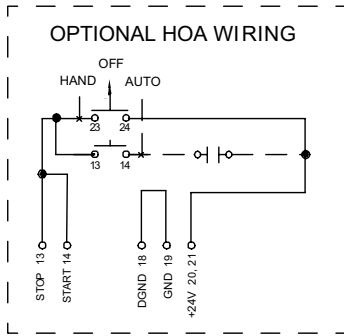

\* Only on PSTX470 ... PSTX1250

**PSTX30 ... PSTX1250**

**In-line connected with line contactor and fuses**

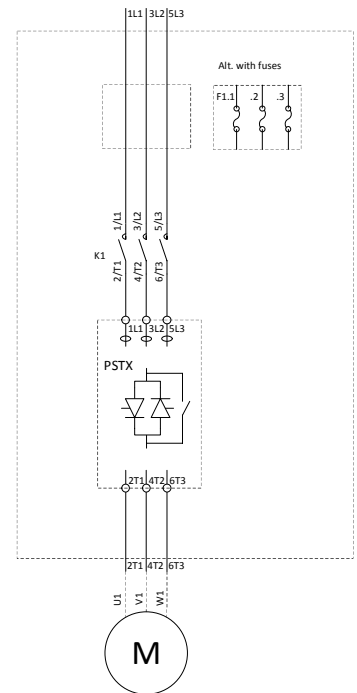
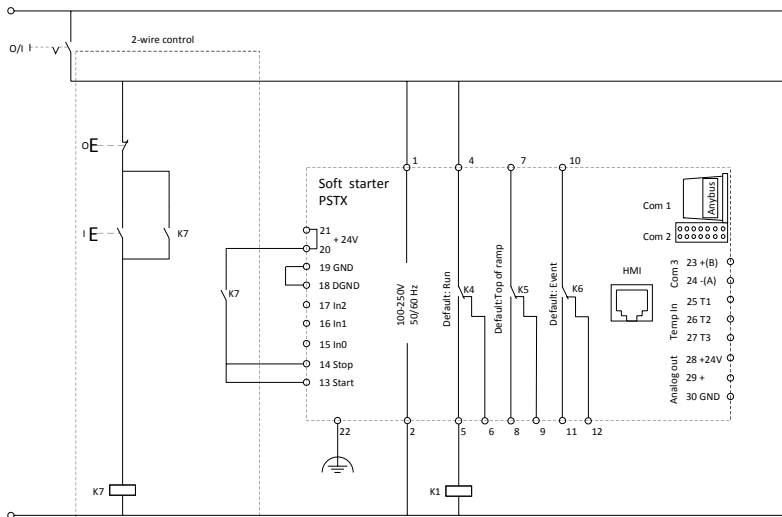

Coil consumption for main contactors.  
Pull-in max 15A  
Holding max 1.5A

If the pull-in or holding values are higher, the main contactors must be controlled via an auxiliary contactor.

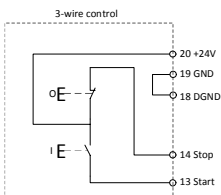

For more circuit diagrams see [new.abb.com/low-voltage/products/Softstarters](http://new.abb.com/low-voltage/products/Softstarters)

# Wall mounting

## Instructions

Product	Minimum distance to wall mm (in)			
	A	B	C	D
PSTX30 ... PSTX105	100 (3.94)	10 (0.39)	20 (0.79)	35 (1.38)
PSTX142 ... PSTX170	100 (3.94)	10 (0.39)	20 (0.79)	35 (1.38)
PSTX210 ... PSTX370	100 (3.94)	10 (0.39)	20 (0.79)	35 (1.38)
PSTX470 ... PSTX570	150 (5.91)	15 (0.59)	20 (0.79)	35 (1.38)
PSTX720 ... PSTX840	150 (5.91)	15 (0.59)	20 (0.79)	35 (1.38)
PSTX1050 ... PSTX1250	150 (5.91)	15 (0.59)	20 (0.79)	35 (1.38)

Minimum distance to front

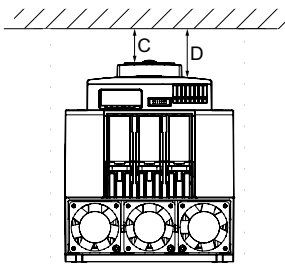

Minimum distance to wall

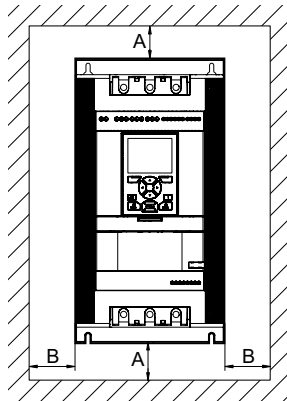

Maximum mounting angle

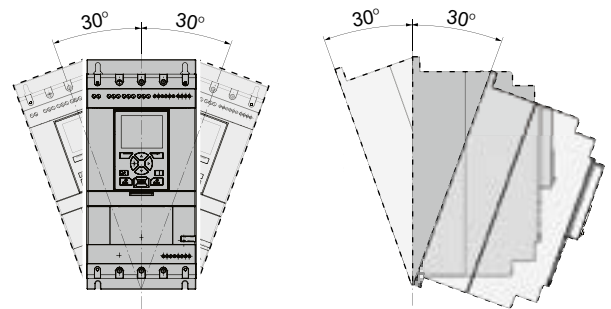







Items included in the box with the softstarter

	Multi-language manual	Terminal kit	Cable and mounting kit for detachable keypad
PSTX30 ... PSTX1250	•	—	•

# Certifications and approvals

The table below shows the certifications and approvals for ABB softstarters. For other certifications and/or approvals, please contact ABB.

Certifications and approvals													
Abbreviation approved in	Certifications						Approvals: ship classification societies						
							KC	ABS	DNV GL	Lloyd's Register	CCS	PRS	Class NK
PSTX30 ... PSTX1250	•	•	•	•	•	•	•	•	•	•	•	•	•

• Standard design approved, the products wear the certification mark when it is required.

## Directives and standards

No. 2006/95/EC	Low voltage equipment
No. 2004/108/EC	Electromagnetic compatibility
EN 60947-1	Low-voltage switchgear and controlgear - Part 1: General rules
EN 60947-4-2	AC semiconductor motor controllers and starters
UL 508	Industrial Control Equipment
CSA C22.2 No 14	Industrial Control Equipment

# Marketing materials and tools

It is easy to access more information about ABB softstarters online. On our web page you will find tools for selection, coordination tables, CAD drawings and different types of documentation.



## Advanced selection tool: proSoft

Download here: [Link](#)

## Online softstarter selection tool

Fast and easy selection of softstarter on any device.



[www.abbcontrol.fr/Softstarter](http://www.abbcontrol.fr/Softstarter)



## Coordination tables

Online tool for coordination with short circuit protection, overload protection and line contactor.



[applications.it.abb.com/SOC](http://applications.it.abb.com/SOC)

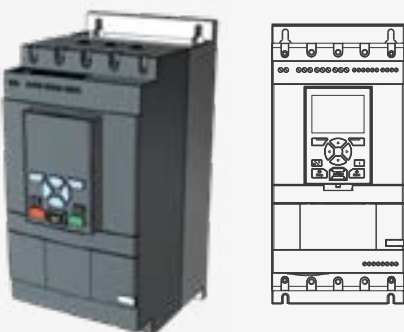

## Download 2D and 3D drawings in any format

Use our Cadenas portal to download CAD drawings to all our Softstarters.



[Cadenas portal for CAD drawings](#)

# Marketing materials and tools



## More information online

- Marketing materials
- Certificates and approvals
- Product simulator
- Circuit diagrams and application diagrams
- EDS- and GSD-files for fieldbus connection
- Softstarter selection tool



[new.abb.com/  
low-voltage/  
products/  
Softstarters](http://new.abb.com/low-voltage/products/Softstarters)



[http://new.abb.  
com/low-  
voltage/  
launches/pstx](http://new.abb.com/low-voltage/launches/pstx)



## SoftstarterCare™ – Service Engineer Tool

Software for easy set-up of PSTX, using a PC.



[new.abb.com/low-  
voltage/products/  
Softstarters](http://new.abb.com/low-voltage/products/Softstarters)





—  
For more information, please contact  
your local ABB representative or visit

[www.abb.com/drives](http://www.abb.com/drives)

[www.new.abb.com/low-voltage/products/softstarters](http://www.new.abb.com/low-voltage/products/softstarters)



To get more information,  
install QR code reader on  
your mobile device, scan the  
code and see more.